

Varenummer: 0101089
 Beskrivelse: Seeger låsering A 82 DIN 471
 Fjederstål
 Note: Monteres med ZGA tang

Mål

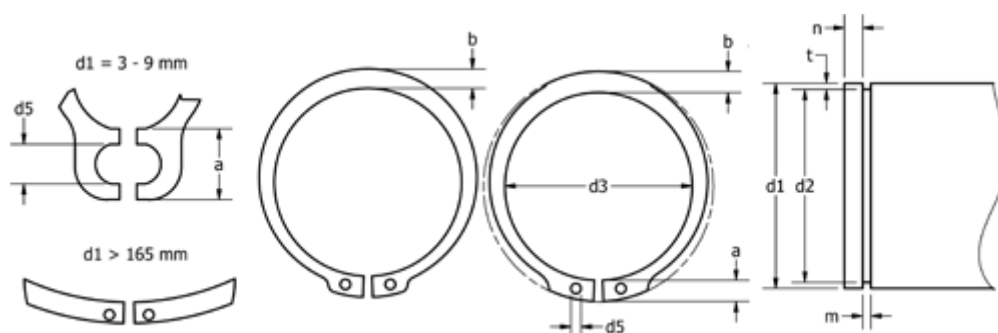

a max	= 8,7	FN kN	= 73.5	s	= 2.50
AN mm ²	= 441.0	FRg kN	= 19.60	t	= 1.75
b	= 7.6	FR kN	= 128.00	Tang	= ZGA-3
Betegnelse	= A82	g	= 3.0	tol	= -0.07
d1	= 82	K kN-mm	= 237.00	tol	= +0,46-1,10
d2	= 78.5	m min	= 2.65	tol	= -0.30
d3	= 76.5	n abl x 1000	= 6.0	vægt kg/1000	= 31.200
d5 min	= 3.0	Nominel træk	= 5.3		